

2.4 YL-HE



MRV	LCAC			
	Smart Power	Super Match	R410A ON/OFF	R22 ON/OFF
		√	√	√

- Individual control
- Cooling only

Parts and Functions

• Buttons of the remote controller

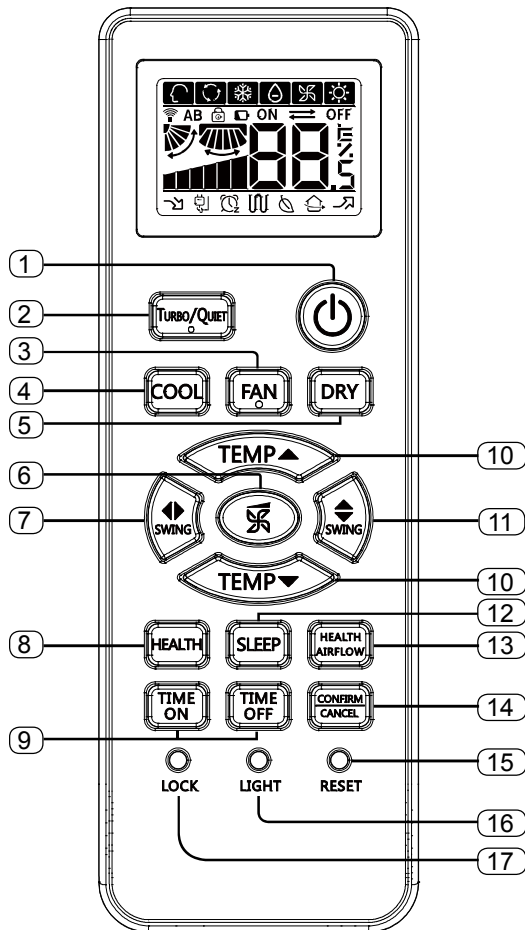

1. POWER button
2. TURBO/QUIET button
3. FAN button
4. COOL button
5. DRY button
6. FAN SPEED button
7. SWING LEFT/RIGHT button
8. HEALTH button
9. TIME OFF/ON button
10. TEMP button
11. SWING UP/DOWN button
12. SLEEP button
13. HEALTH AIR FLOW button
14. CANCEL/CONFIRM button
15. RESET button

Function: Setting and cancel to the timer
When the remote controller appears abnormal, use a sharp pointed article to press this button to reset the remote.

16. LIGHT button
17. LOCK button

• Display of the remote controller

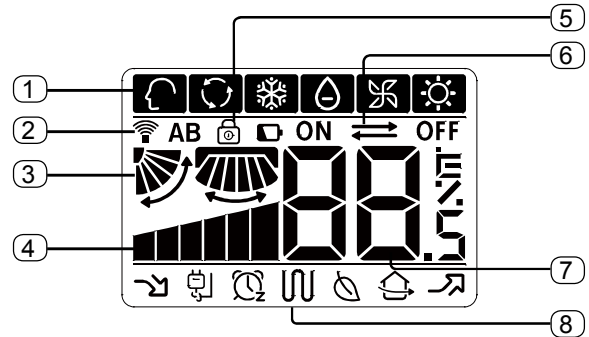

1. Mode display

Operation mode	COOL	DRY	FAN
Remote controller			

2. Signal sending display

3. SWING display

4. FAN SPEED display

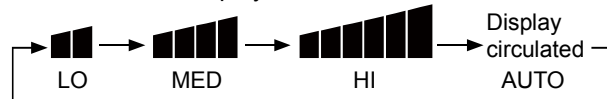

5. LOCK display

6. TIMER OFF display TIMER ON display

7. TEMP display

8. Additional functions display

Operation mode	QUIET	SLEEP	HEALTH	TURBO
Remote controller				

• Loading of the battery

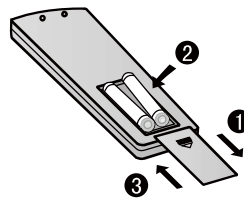

1. Remove the battery cover;
2. Load the batteries as illustrated. 2 R-03 batteries, resetting key (cylinder);
3. Be sure that the loading is in line with the " + "/"-";
4. Load the battery, then put on the cover again.

Note:

- The distance between the signal transmission head and the receiver hole should be within 7m without any obstacle as well.
- When electronic-started type fluorescent lamp or change-over type fluorescent lamp or wireless telephone is installed in the room, the receiver is apt to be disturbed in receiving the signals, so the distance to the indoor unit should be shorter.
- Full display or unclear display during operation indicates the batteries have been used up. Please change batteries.
- If the remote controller can't run normally during operation, please remove the batteries and reload several minutes later.

Operation

NO. 0150519130

• **Base Operation**

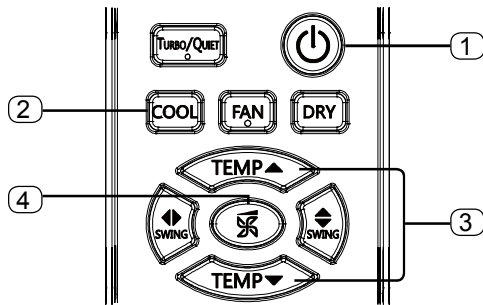

1. Unit start

Press ON/OFF on the remote controller, unit starts.

2. Select operation mode

COOL button: Cooling mode

FAN button: Fanning mode

DRY button: Dehumidify mode

3. Select temp. setting

Press / button

Every time the button is pressed, temp. setting increase 1°C, if kept depressed, it will increase rapidly.

Every time the button is pressed, temp. setting decrease 1°C, if kept depressed, it will decrease rapidly.

Select a desired temperature.

4. Fan speed selection

Press FAN button. For each press, fan speed changes as follows:

Remote controller:

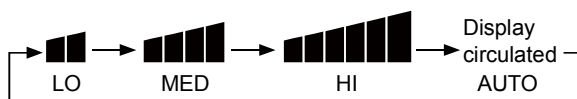

• **Air Flow Direction Adjustment**

1. Status display of air flow

Vertical flap

Pos.1 (Auto swing)

Initial state

Pos.2 No initial state displayed on remote controller, the vertical flap will be fixed on the current position

2. Left and right air flow adjustment

For each press of button, remote controller displays as follows :

remote controller:

Pos.1	Pos.2	Pos.3	Pos.4	Pos.5	Pos.6

• **TURBO/QUIET Operation**

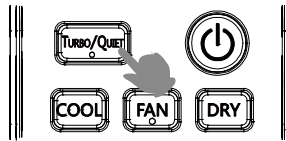

When you need fast cool or fast dehumidify function, you can choose the Turbo function; when you sleep, read, you can choose Quiet function

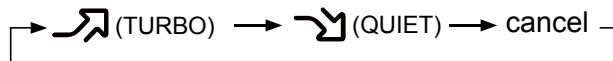

Press the button, you can switch the "Turbo" and "Quiet" function easily. Every press, the remote controller will switch as below:



When running in Turbo, the fan speed is the highest, when running in Quiet, the fan speed is super slow.

• Timer On/Off On-Off Operation

1. After unit starts, select your desired operation mode.

2. Press  /  button to change TIMER mode.
Every time the button is pressed, display changes as follows:

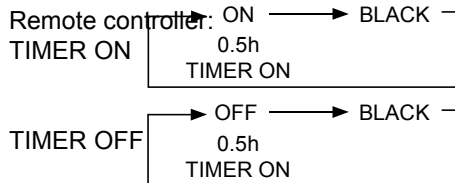

Then select your desired TIMER mode (TIMER ON or TIMER OFF). "ON" or "OFF" will flash

3. Press  /  button to set time.

Press the button for each time, setting time in the first 12 hours increased by 0.5 hour every time, after 12 hours, increased by 1 hour every time.

4. Confirm timer setting

After adjust the time, press  button and confirm the time ON or OFF button will not flash any more.

5. Cancel timer setting

Press the timer button by times until the time display eliminated.

Hints:

- After replacing batteries or a power failure happens, time setting should be reset.
- According to the Time setting sequence of TIMER ON or TIMER OFF, either Start-Stop or Stop-Start can be achieved.

Note:

1. After setting the healthy airflow function, the position grill is fixed.
2. In cooling, it is better to select the  mode.
3. In cooling and dry, using the air conditioner for a long time under the high air humidity, condensate water may occur at the grille .

• Health airflow Operation

1. Press  to starting

Setting the comfort work conditions.

2. The setting of healthy airflow function

Press button to select "Healthy airflow", the remote controller will switch as below:

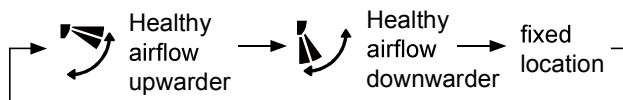

Notice: Do not direct the flap by hand. Otherwise, the grille will run incorrectly. If the grille is not run correctly, stop for a minute and then start, adjusting by remote controller.